

Features/特徴

- Automatic winding ensures high quality
自動巻線で高品質を実現
- Compact and low loss
小型で低損失を実現
- High noise suppression performance over a wide frequency range.
広い周波数領域でノイズ抑制効果を実現
- Closed magnetic core reduces leakage flux and achieves compact size.
閉磁路コア使用により、小型で漏れ磁束を軽減

SQ19V



SQ19H



Applications/用途

- Line filters for TVs and AC adapters, etc.
TV・ACアダプタのラインフィルターなど
- For various switching power supply circuits
各種スイッチング電源回路用

Schematic & Winding Direction

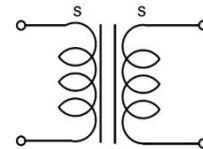

Dimensions

SQ19V

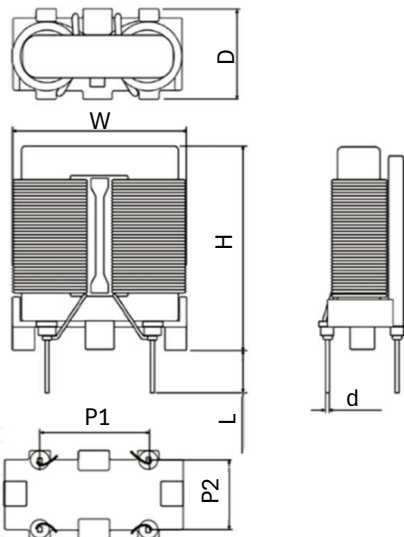

SQ19H

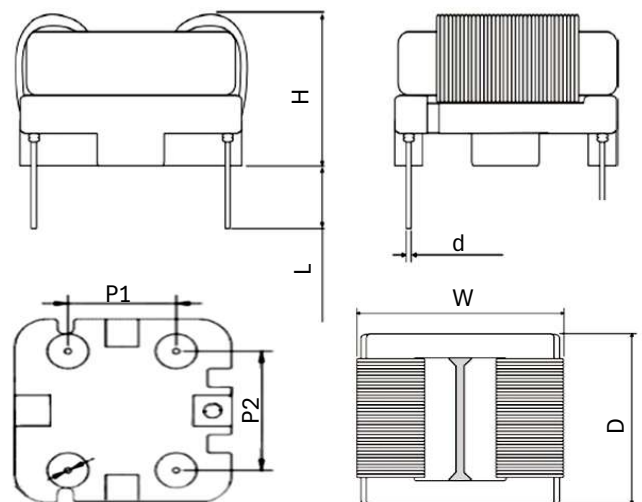

Type	W	D	H	L	d	P1	P2
SQ19V	25.0 max	14.0max	26.0 max	3.5±0.5	□0.8±0.1	13.0±0.5	10.0±0.5
SQ19H	24.0 max	23.0 max	13.5 max	3.5±0.5	0.8±0.1	13.0±0.5	10.0±0.5

Electrical Characteristics

• SQ19

Part Number	Inductance	DC Resistance	Rated current
	(mH) Min.	(mΩ) Max.	(Arms)
SQ19V(H)-1526R000	1.5	25	6.0
SQ19V(H)-4025R000	4.0	30	5.0
SQ19V(H)-7523R400	7.5	65	3.4
SQ19V(H)-1033R000	10.0	85	3.0
SQ19V(H)-1532R200	15.0	140	2.2
SQ19V(H)-2431R800	24.0	280	1.8

- 定格電圧 [Rated Voltage]、AC/DC 250V
- 使用温度範囲 [Operating Temperature Range]、-25~120°C
- 絶縁耐圧 [Withstanding Voltage]、AC1500V 60sec. or AC1800V 1~2sec.(LINE to LINE)
- 絶縁抵抗 [Insulation Resistance]、DC500V, 100M Ωmin.(LINE to LINE)

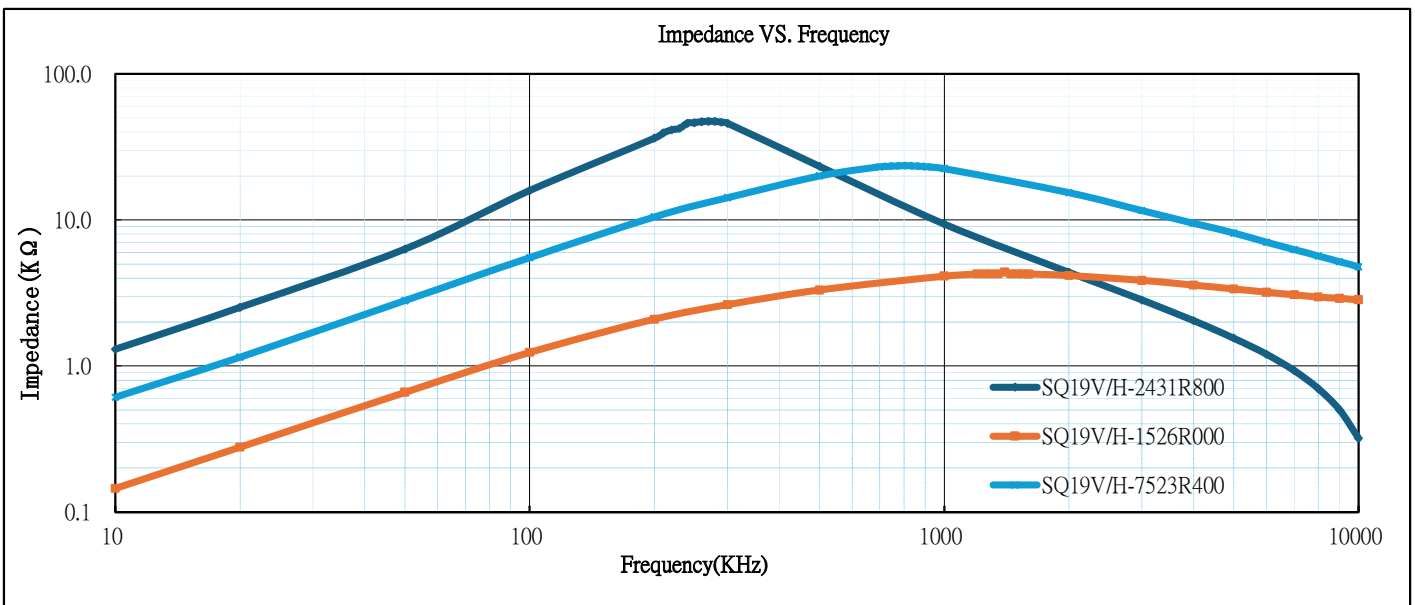

Conditions/測定条件

- (1) Measurement Frequency : 10kHz.
測定周波数 : 10kHz.
- (2) Measurement Temperature : 23±2°C.
測定温度 : 23±2°C.
- (3) This catalog contains the typical products only. As casutam specification are available.

We are ready to comply with your request.

本カタログには代表的な製品の仕様しか記載しておりません。当社製品のご使用を検討いただく際には、納入仕様書にて、詳細な仕様の確認をお願い致します。カスタム品も製造しておりますので、ご遠慮なく申しつけてください。